

ROHS COMPLIANT

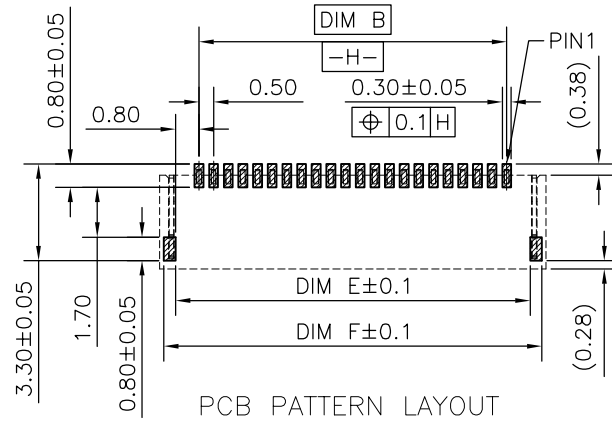
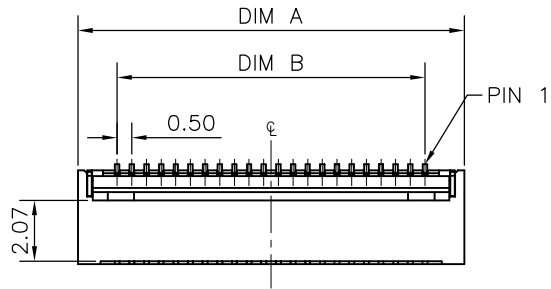

NOTES:

1. MATERIAL:

- 1.1 HOUSING: THERMOPLASTIC, HIGH TEMP.UL94V-0; COLOR:WHITE.
- 1.2 ACTUATOR: THERMOPLASTIC, HIGH TEMP.UL94V-0; COLOR:BLACK.
- 1.3 CONTACT: COPPER ALLOY
- 1.4 FITTING NAIL: COPPER ALLOY

2. FINISH:

2.1 CONTACT:

- 50~100u" NICKEL UNDERPLATING OVERALL.
- 3u" GOLD ON CONTACT AND GOLD FLASH ON SOLDER

2.2 FITTING NAIL:

- 100~150u" TIN PLATING ON SOLDER TAILS(LEAD FREE).
- 50~100u" NICKEL UNDERPLATING OVERALL.

ORDER CODE:

ZIFD xx -0.5DF-R

No contacts; 04-30

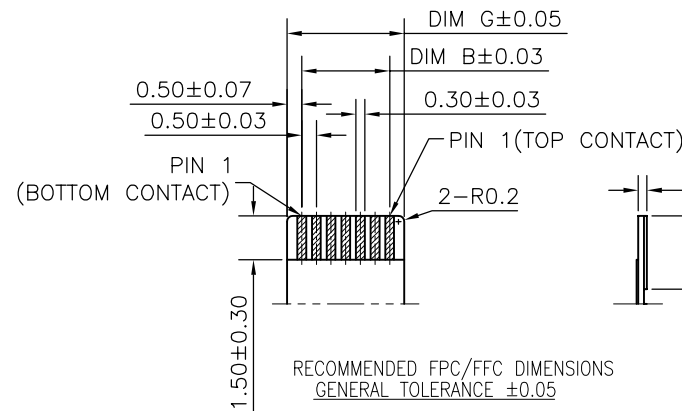
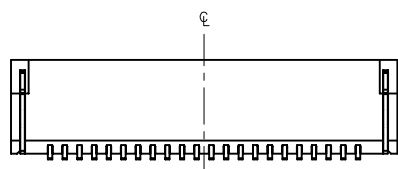
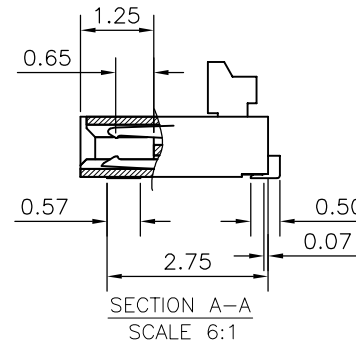
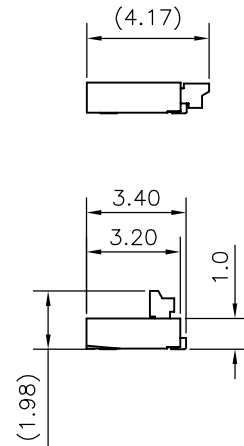
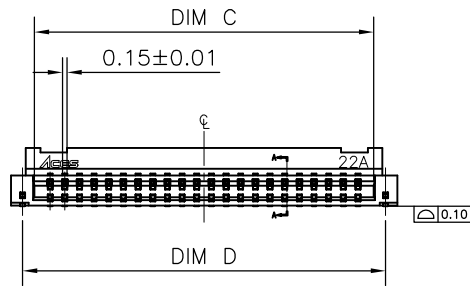

CKT	DIM A	DIM B	DIM C	DIM D	DIM E	DIM F	DIM G
4	4.18	1.50	2.57	3.38	3.10	3.90	2.50
5	4.68	2.00	3.07	3.88	3.60	4.40	3.00
6	5.18	2.50	3.57	4.38	4.10	4.90	3.50
7	5.68	3.00	4.07	4.88	4.60	5.40	4.00
8	6.18	3.50	4.57	5.38	5.10	5.90	4.50
9	6.68	4.00	5.07	5.88	5.60	6.40	5.00
10	7.18	4.50	5.57	6.38	6.10	6.90	5.50
11	7.68	5.00	6.07	6.88	6.60	7.40	6.00
12	8.18	5.50	6.57	7.38	7.10	7.90	6.50
13	8.68	6.00	7.07	7.88	7.60	8.40	7.00
14	9.18	6.50	7.57	8.38	8.10	8.90	7.50
15	9.68	7.00	8.07	8.88	8.60	9.40	8.00
16	10.18	7.50	8.57	9.38	9.10	9.90	8.50
17	10.68	8.00	9.07	9.88	9.60	10.40	9.00
18	11.18	8.50	9.57	10.38	10.10	10.90	9.50
19	11.68	9.00	10.07	10.88	10.60	11.40	10.00
20	12.18	9.50	10.57	11.38	11.10	11.90	10.50
21	12.68	10.00	11.07	11.88	11.60	12.40	11.00
22	13.18	10.50	11.57	12.38	12.10	12.90	11.50
23	13.68	11.00	12.07	12.88	12.60	13.40	12.00
24	14.18	11.50	12.57	13.38	13.10	13.90	12.50
25	14.68	12.00	13.07	13.88	13.60	14.40	13.00
26	15.18	12.50	13.57	14.38	14.10	14.90	13.50
27	15.68	13.00	14.07	14.88	14.60	15.40	14.00
28	16.18	13.50	14.57	15.38	15.10	15.90	14.50
29	16.68	14.00	15.07	15.88	15.60	16.40	15.00
30	17.18	14.50	15.57	16.38	16.10	16.90	15.50

QUALITY SYMBOLS MAJOR Ⓜ CRITICAL Ⓢ	DRAWN BY Wang, Kai Hung	DATE 18/01/17	GTK UK LTD.
	CHECKED BY Liu, Yuan Huang	DATE 18/01/17	
GENERAL TOLERANCES (UNLESS SPECIFIED)  X. ±0.5 .X ±0.25 .XX ±0.15 .XXX ±0.1 ANGLES ±2°	APPROVED BY Hisatomi, Kazukuni	DATE 18/01/17	TITLE 0.5MM PITCH ZIF BACK-FLIP FPC CONN SMT R/A D/C
	UNITS mm	SCALE 4:1	SIZE A4 SHEET NO. 1 OF 1 REV D